

# hülsta-HOMEOFFICE



The straightforward design of the **hülsta-HOMEOFFICE** catches the eye, and it is just this simplicity which gives it its special radiance. The hülsta-HOMEOFFICE desk collection is characterised by its straight forms, simplicity, innovations and its focus on practical features.

**Extendable desk concept E - F:** A desk collection in a variety of dimensions and functions which enables desk linking and round-the-corner combinations.

One can create an endless number of new configurations, such as single, team and group workplaces. The range also meets requirements of a wide range of different room sizes and shapes: it is possible to place the units centrally in the room as well as by a wall or in a corner. Everything imaginable is now also "do-able".

### Additional units/accessories/functional units:

**Mobile container** with 3 drawers

All drawers with pull-out brake and **hülsta-SoftFlow**

**Lower bookcase and lower drawer:** for fitting below the table surface

### Technical information and details on materials:

**Compact laminate:** HPL is the abbreviation for High Pressure Laminate (acc. to EN 438). A decorative layer of melamine resin, printed or dyed decorative films and a core of extremely solid, resin-impregnated kraft papers. The layer is pressed on under high pressure and great heat to form an homogenous board, which betrays outstanding characteristics in use.

**Cable management:** In the desk E, cables can be fed vertically through a plastic tube. These table surfaces can also be provided with a cable aperture at 4 predetermined positions.

**Standing/sitting workdesk F - adjustment mechanism:** there is a gas pressure spring inside the column, which can be operated by means of a footswitch. This switch can be positioned at either side of the desk so that it is as easy to operate as possible. When the switch is operated (by pressing on it), it is possible to lower or raise the work surface by pushing or pulling the table surface by hand.

**Closing the containers:** there is an optional central locking system with the cylinder lock available. It is positioned in the top front section of the drawer on the right-hand side.

**Brake mechanism:** it is only possible for the user of the container to open one drawer at a time, to prevent the container from tipping over.

### Further notes:

- There is no veneer matching for desk combinations
- The veneer direction of the standing/sitting workplaces cannot be changed
- GS sign (for tested safety) for the mobile containers

## Extendable desk concept

### Extendable desk concept E - F:

A desk collection in a variety of dimensions and functions which enables desk linking and round-the-corner combinations.



### List of versions

Model no.	Versions	Price group
363	White lacquer	I
275	Beech	I
279	Structured beech	I
364	Natural maple	II
276	Alder	II
365	Oak mocca	II
278	Natural oak	II
<b>NEW</b> 376	Light brown ash	II
372	Cherrywood gold	II
367	Walnut	II
<b>NEW</b> 377	Core walnut	II
361	White laminate*	IV
362	Black laminate*	IV

\* Only table surfaces in laminate  
 All desk substructures available in 4 optional surface versions  
 All desks 72 cm high, with legs (adjustable in height by 4 mm)

## Desk E

72.0 cm high; 80 cm deep

with a veneered or lacquered table surface, 2.6 cm thick, or with a laminate board, 1.2 cm thick (see list of versions on page 315)

Desk substructure: transverse strut made of steel, graphite powder-coated. The model number for the desk support panels and for the table surface must be stated separately, since colour combinations are possible (desk support panels not available in laminated versions). Please state this clearly in the order! When changing versions between different price groups, the higher price group is always charged. If no details about the version of the desk support panels are given in the order, the desk support panels are delivered in the same version as the table surface (for table surfaces in the white and black laminate version, the desk support panels are delivered in white lacquer).

The extendable desk E (see below) can be fitted on to desk E.

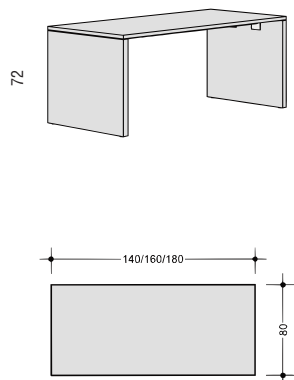

140 x 80 cm	Price gr.	<b>3547</b>
	I	-
	II IV	- -
160 x 80 cm	Price gr.	<b>3567</b>
	I	-
	II IV	- -
180 x 80 cm	Price gr.	<b>3587</b>
	I	-
	II IV	- -

## Extendable desk E

### Extendable desk E

72.0 cm high; 80 cm deep

with a veneered or lacquered table surface, 2.6 cm thick, or with a laminate board, 1.2 cm thick (see list of versions on page 315)

Desk substructure: transverse strut made of steel, graphite powder-coated. The model number for the desk support panel and for the table surface must be stated separately, since colour combinations are possible (desk support panel not available in laminated versions). Please state this clearly in the order! When changing versions between different price groups, the higher price group is always charged. If no details about the version of the desk support panel are given in the order, the desk support panel is delivered in the same version as the table surface (for table surfaces in the white and black laminate version, the desk support panel is delivered in white lacquer).

The extendable desk E can only be fitted on to desk E (see above) or on to desk F (see page 317).

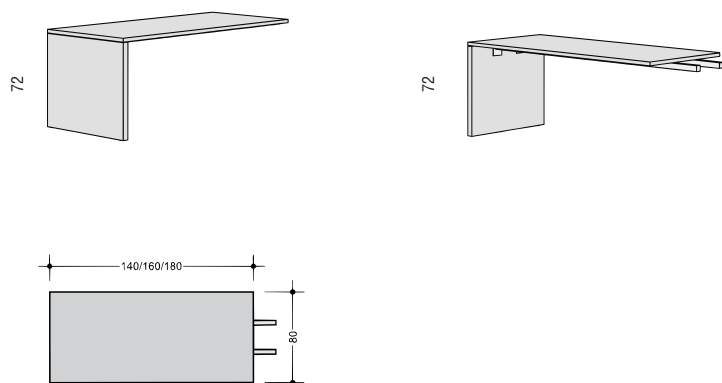

140 x 80 cm	Price gr.	<b>3548</b>
	I	-
	II IV	- -
160 x 80 cm	Price gr.	<b>3568</b>
	I	-
	II IV	- -
180 x 80 cm	Price gr.	<b>3588</b>
	I	-
	II IV	- -

## Work desk F

with baseplate, 72.0 cm high; 80 x 80 cm

with a veneered or lacquered table surface, 2.6 cm thick, or with a laminate board, 1.2 cm thick (see list of versions on page 315)

desk substructures optionally in four different surface versions

The work desk F can be used separately or fitted on to extendable desk E (see page 316).

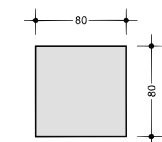

		Substructure powder-coated graphite	Substructure powder-coated white	Substructure powder-coated silver	Substructure high-gloss chrome
80 x 80 cm	<b>Price gr.</b> I II IV	<b>4197</b>	<b>4297</b>	<b>4597</b>	<b>4397</b>
		-	-	-	-
		-	-	-	-

## Standing/sitting work desk F

### Standing/sitting work desk F



with baseplate, adjustable to any height from 72.0-115.5 cm by footswitch; 80 x 80 cm

with a veneered or lacquered table surface, 2.6 cm thick, or with a laminate board, 1.2 cm thick (see list of versions on page 315)

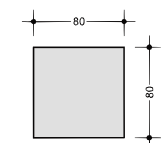
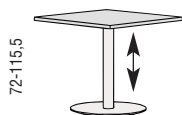
desk substructures optionally in four different surface versions

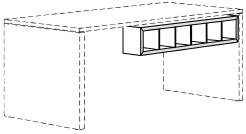
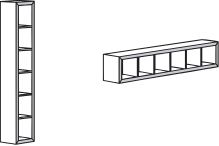
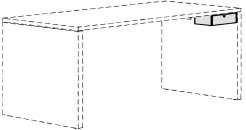
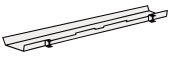

		Substructure powder-coated graphite	Substructure powder-coated white	Substructure powder-coated silver	Substructure high-gloss chrome
80 x 80 cm	<b>Price gr.</b> I II IV	<b>4198</b>	<b>4298</b>	<b>4598</b>	<b>4398</b>
		-	-	-	-
		-	-	-	-

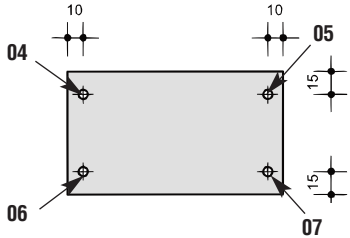
<p><b>Lower bookcase</b> 109.3 cm wide, 20.0 cm high, 17.5 cm deep; for fitting below desk surface, optionally left, right or in the middle (not possible for desk surfaces of laminate). Please mark the position clearly in the order! With rear wall. Not available in laminate versions!</p>  <p>Usable dims. per compartment: 14.9 cm high 16.5 cm wide 15.2 cm deep</p>	<p>Price gr. I II IV</p>	<p>121 - - -</p>							
<p><b>Wall bookcase</b> 109.3 cm wide, 20.0 cm high, 17.5 cm deep; for fitting anywhere on wall (horizontally and vertically). With rear wall. Not available in laminate versions!</p>  <p>Usable dims. per compartment: 14.9 cm high 16.5 cm wide 15.2 cm deep</p>	<p>Price gr. I II IV</p>	<p>122 - - -</p>							
<p><b>Lower drawer</b> 29.5 cm wide, 7.4 cm high, 17.5 cm deep; of solid wood; for fitting below desk surface, optionally left or right (not possible for desk surfaces of laminate). Please mark the position clearly in the order! Not available in white lacquer, light brown ash or laminate versions! Please note: Mobile containers can not be placed under the lower drawer.</p>  <p>Usable dims.: 5.4 cm high 27.5 cm wide 15.5 cm deep</p>	<p>Price gr. I II IV</p>	<p>123 - - -</p>							
<p><b>Fold-down cable tub</b> of metal, graphite powder-coated; with tension release; for fitting below desk surface</p> 	<p>120 cm long (for desk lengths 140 and 160 cm)</p>	<p>220 -</p>							
	<p>160 cm long (for desk length 180 cm)</p>	<p>260 -</p>							
<p><b>Horizontal cable management</b> black plastic; for fitting anywhere below desk surface</p> 	<p>100 -</p>								
<p><b>Vertical cable management</b> black plastic; for fitting anywhere below desk surface</p> 	<p>200 -</p>								
<p><b>Electric plug panel</b> White plastic; quadruple socket and 3m lead, for placing in cable tub</p>	<p>124 -</p>								
<p><b>Surcharge for cable aperture in table surface</b> Cable aperture is only possible in fixed positions (= types) 04 to 07 (see sketch). Please state in the order in which position the cable aperture is required.</p> 	<table border="1"> <tr> <td>04</td> <td>05</td> <td>06</td> <td>07</td> </tr> <tr> <td>-</td> <td>-</td> <td>-</td> <td>-</td> </tr> </table>	04	05	06	07	-	-	-	-
04	05	06	07						
-	-	-	-						



**Mobile containers**

<p><b>Mobile container B</b> 62.1 cm high; 42.8 cm wide; 60 or 80 cm deep; on castors (2 castors with brake mechanism); with 3 drawers (drawers with pull-out brake and <b>hülsta-SoftFlow</b>)</p> <p>Usable inside drawer dims.: Height of top drawer: 12.4 cm Height of middle drawer: 13.7 cm Height of lower drawer: 12.1 cm Width: 31.5 cm Depth: 47.4 or 62.4 cm</p>		<p>60 cm deep</p>	<p>Price gr. I II IV</p>	<p><b>536</b> - - -</p>
		<p>80 cm deep</p>	<p>Price gr. I II IV</p>	<p><b>538</b> - - -</p>
<p><b>Utensil drawer for mobile container</b> 1.5 cm high; 36.4 cm wide; 16.0 cm deep; only in solid beech; for 1 Raster drawer</p>				<p><b>105</b> -</p>
<p><b>Central locking system for mobile container</b> Lock is fitted standard in the top right of the front of the top drawer; position: 4 cm from the top and 3.2 cm from the right of the drawer front section</p>				<p><b>9.</b> -</p>